

Data Sheet



Article number: 339702190000

Description: Multibeam 6 Coupling 702.19.0000
St. steel & set screw hubs

Measures

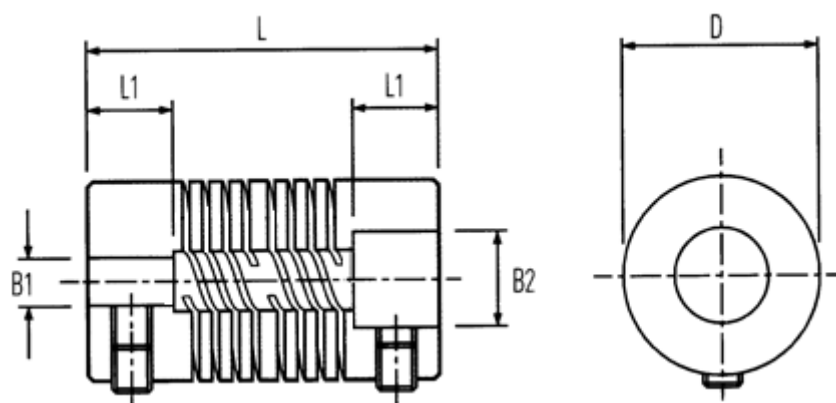

B1: Pre-drilled = 4.8

B2: Pre-drilled = 6.35

D = 19.1

L = 28.0

L1 = 6.5

Max angular displacement = 0.25

Max B1 & B2 = 10.00

Max parallel displacement = 7

Peak Torque NM = 8.00

Set Screw = M4